

# Mining Truck

( dump bed )



Building instructions, part 1

**EXAMPLE**

These building instructions are for personal usage and may not commercially used and/or sold. LEGO is a trademark of the LEGO group of companies which does not sponsor, authorize or endorse these building instructions. Copyright design: Han Crielaard, year 2016, [www.designer-han.nl](http://www.designer-han.nl)



# Information

## Mining Truck

### Dimensions

- 

# Parts	Length	Width	Height	Weight
2.127	37 cm	24 cm	21 cm 39 cm*	2,7 kg

\* With full raised bed

### Technic functions

- Full remote controlled model with working V10 engine,
- Powered by a XL-motor, connected to the rear axle with a double differential unit,
- Steering by a Servo-motor,
- Full individual suspension on all wheels,
- Dump bed tipping driven by 2 M-motors & Linear Actuators,
- Load dump capability 1 kg,
- Front and rear lights equipped with LED's.

### Non-Technic functions

- Cabin door can open & close,
- Adjustable protection shield to assure horizontal leveling.

### Appearance details

- Cabin interior with coffee machine,
- Exhaust pipe, air filter units, horn, gas cylinders and fire extinguisher.

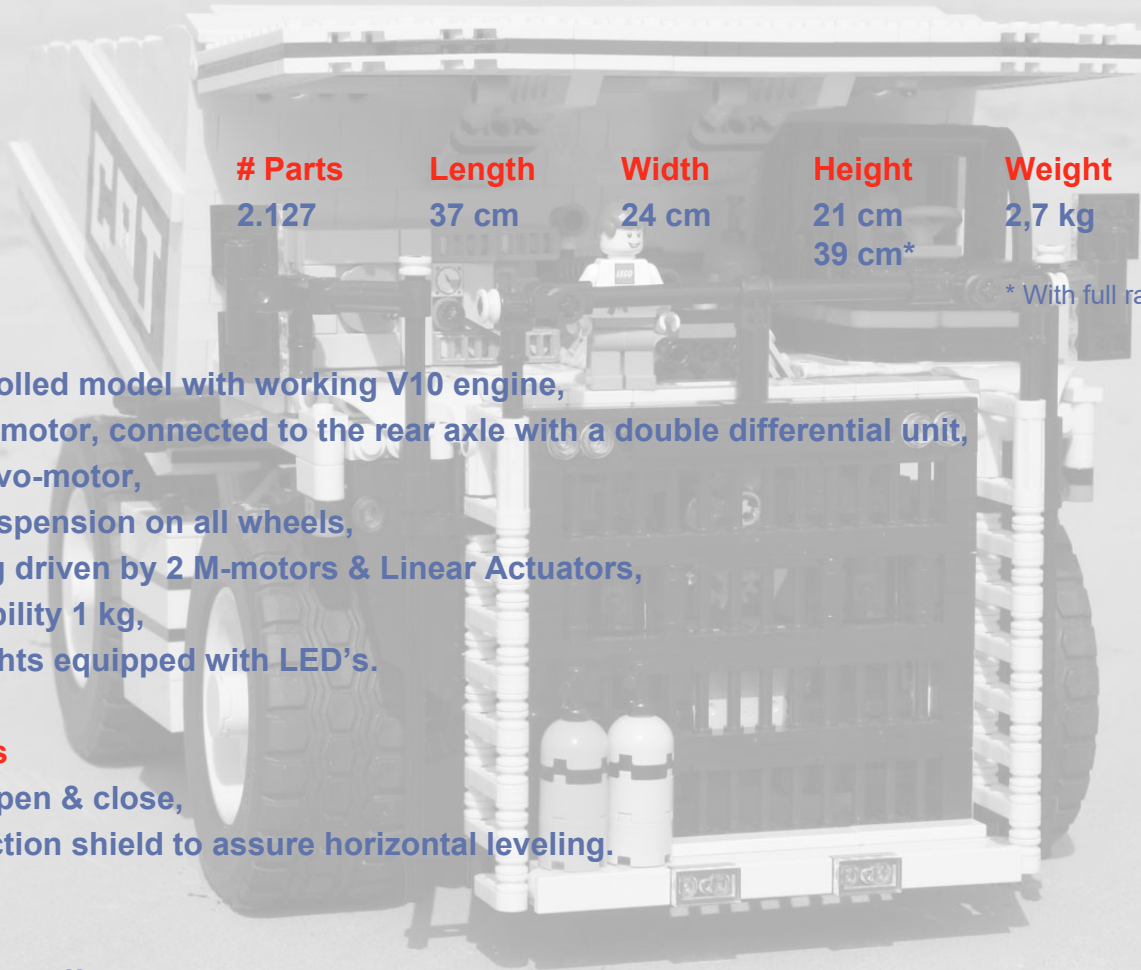

**EXAMPLE**



# Building guidelines

## Parts that may cause confusion



Used in this model

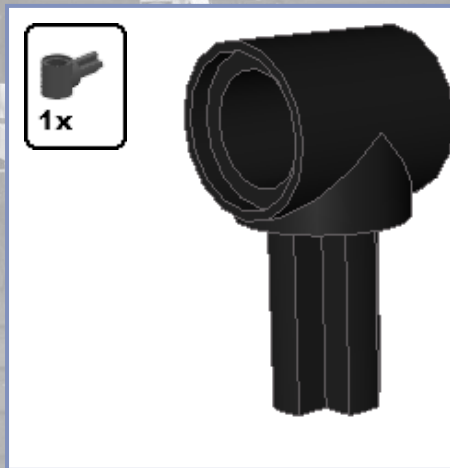

Not used in this model



Used in this model

**EXAMPLE**



# Controller setup (example)

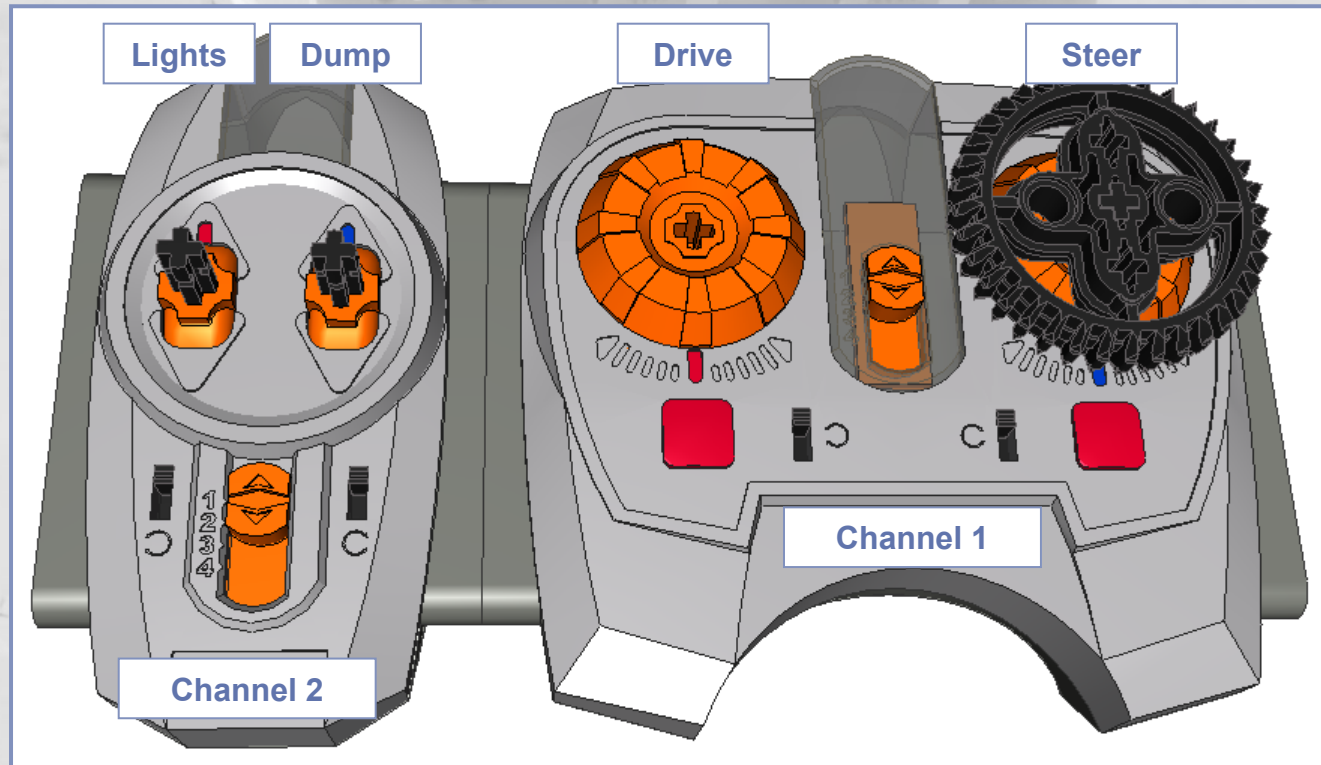

# How to charge or switch on/off the battery unit

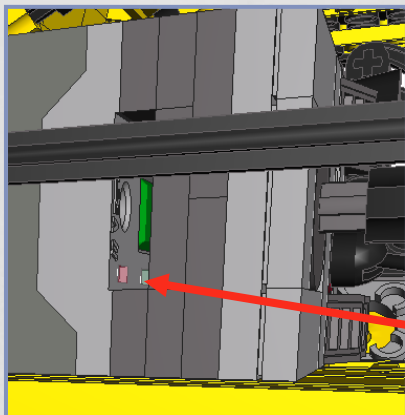
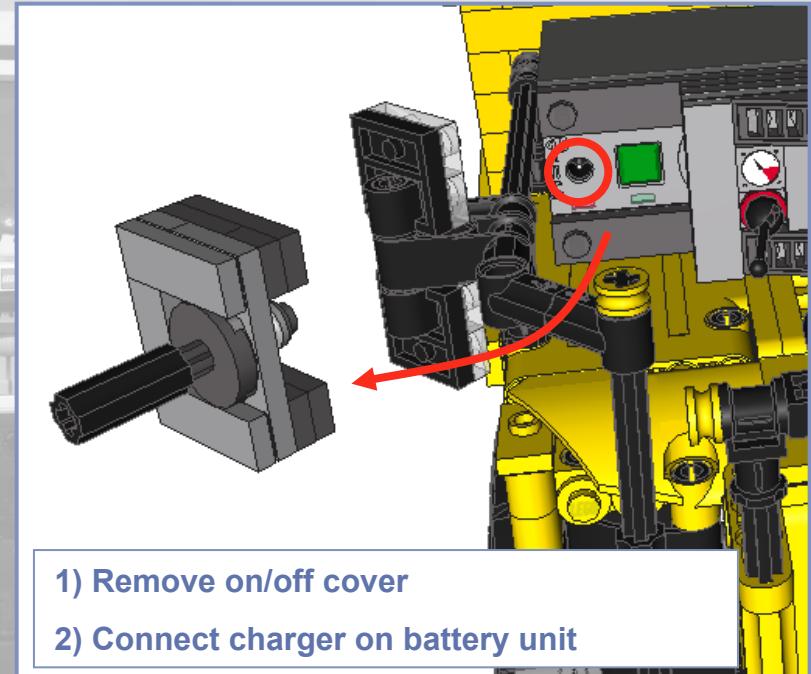
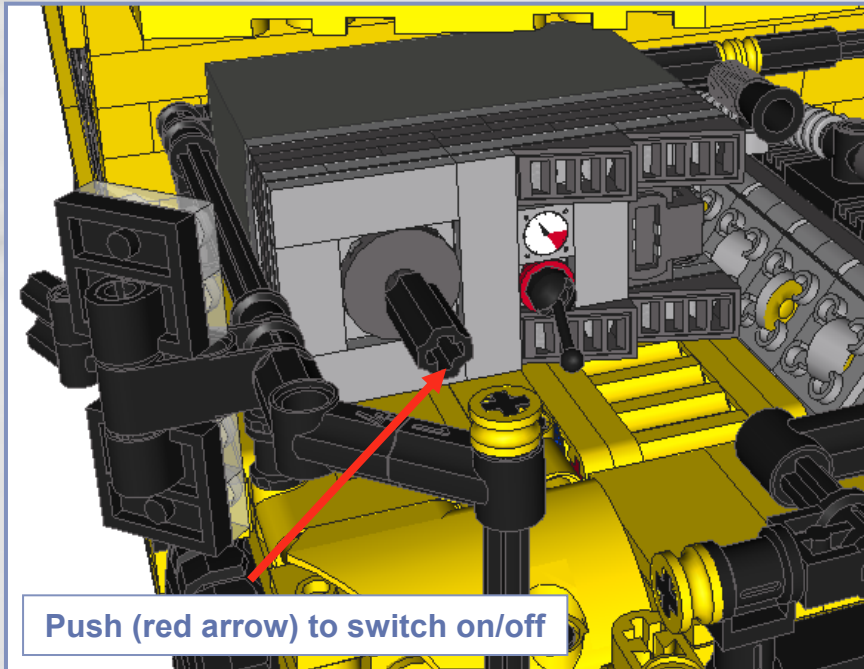

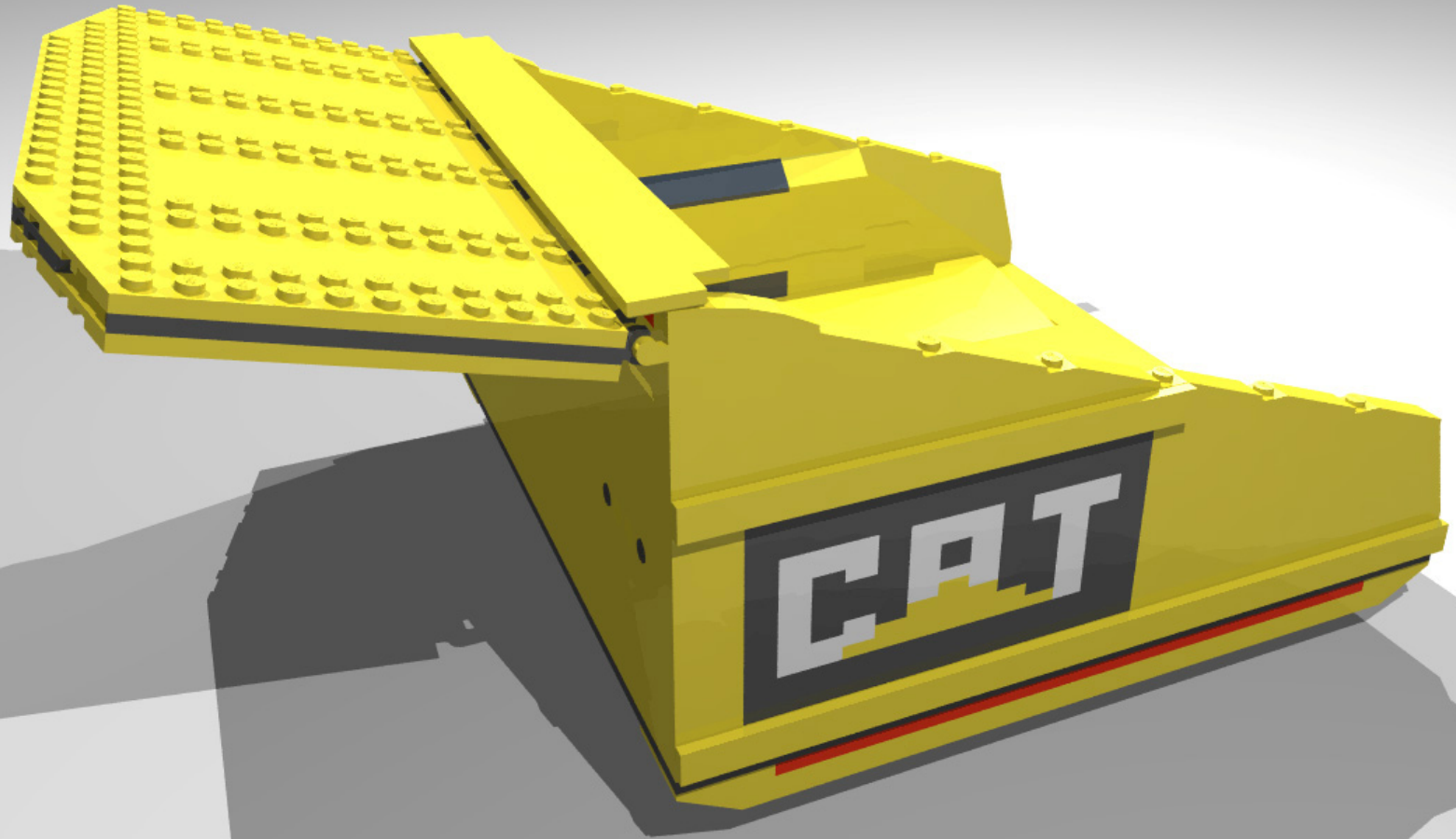

**EXAMPLE**

*These building instructions are for personal usage and may not commercially used and/or sold. LEGO is a trademark of the LEGO group of companies which does not sponsor, authorize or endorse these building instructions. Copyright design: Han Crielaard, year 2016, [www.designer-han.nl](http://www.designer-han.nl)*



# Step 50

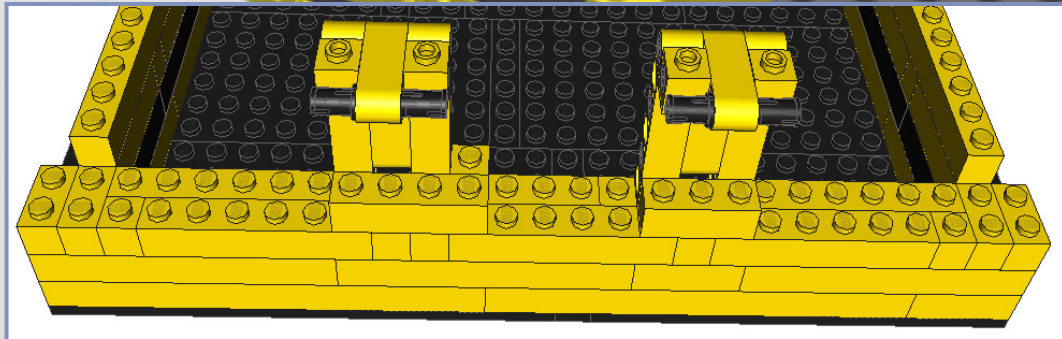
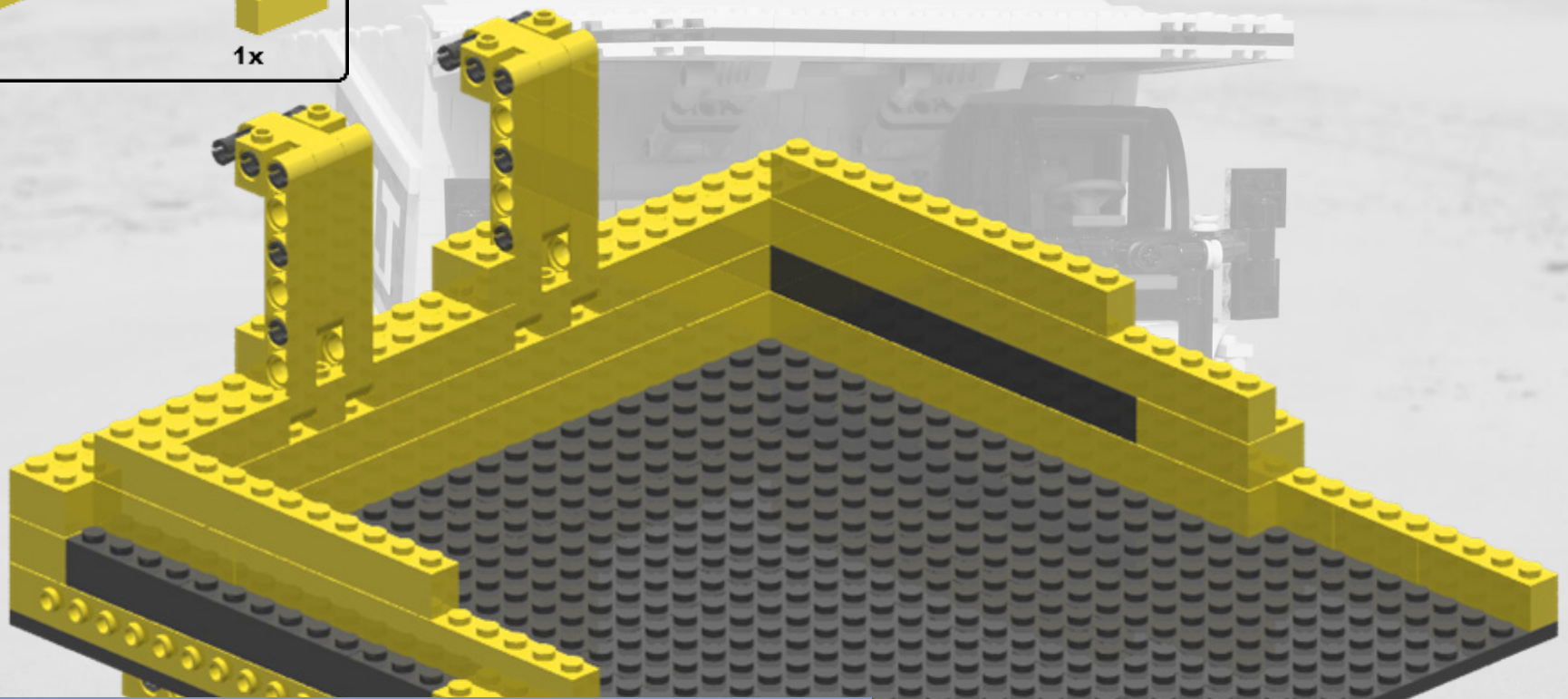
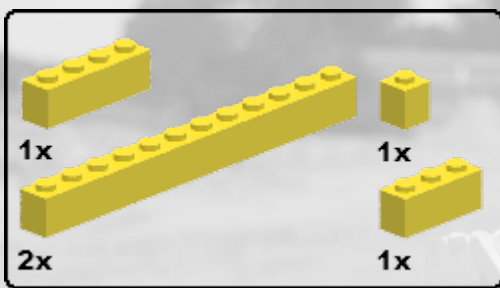

**EXAMPLE**



# Step 51

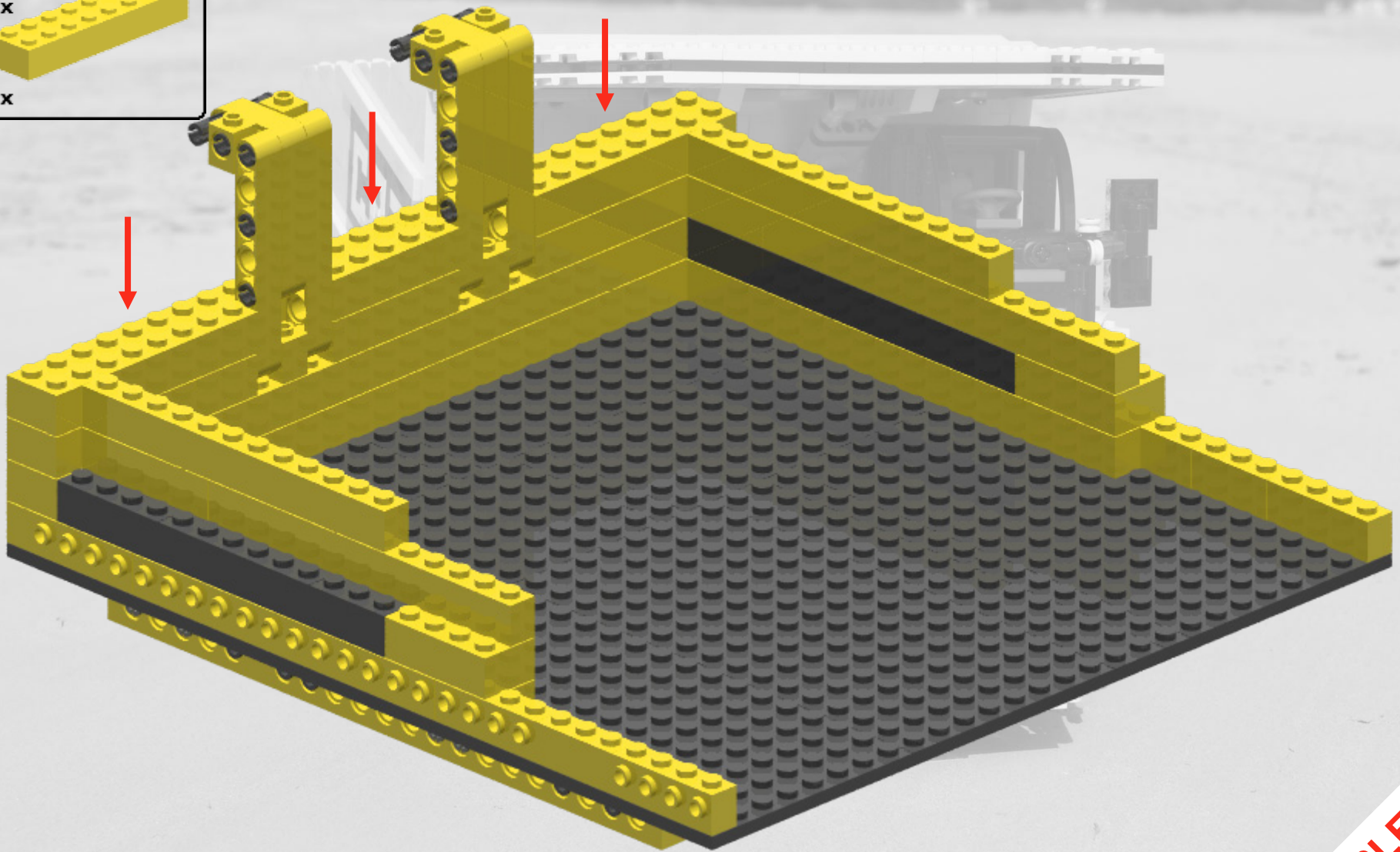
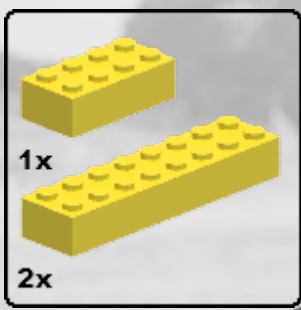



**EXAMPLE**





# Step 52

- 1x 
- 1x 
- 3x 
- 2x 
- 1x 

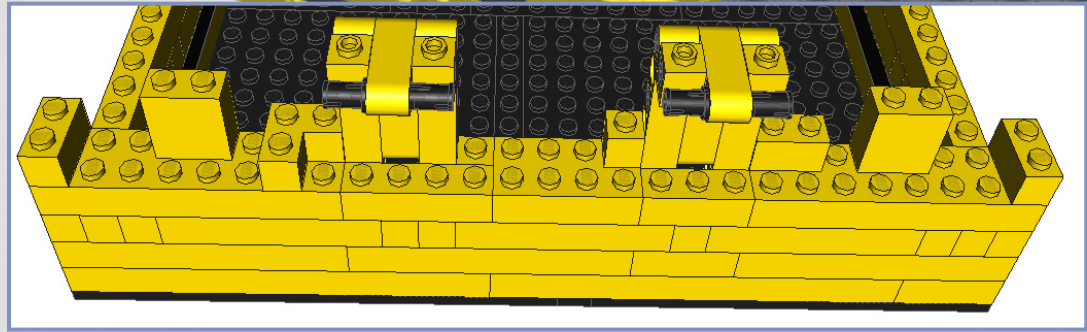
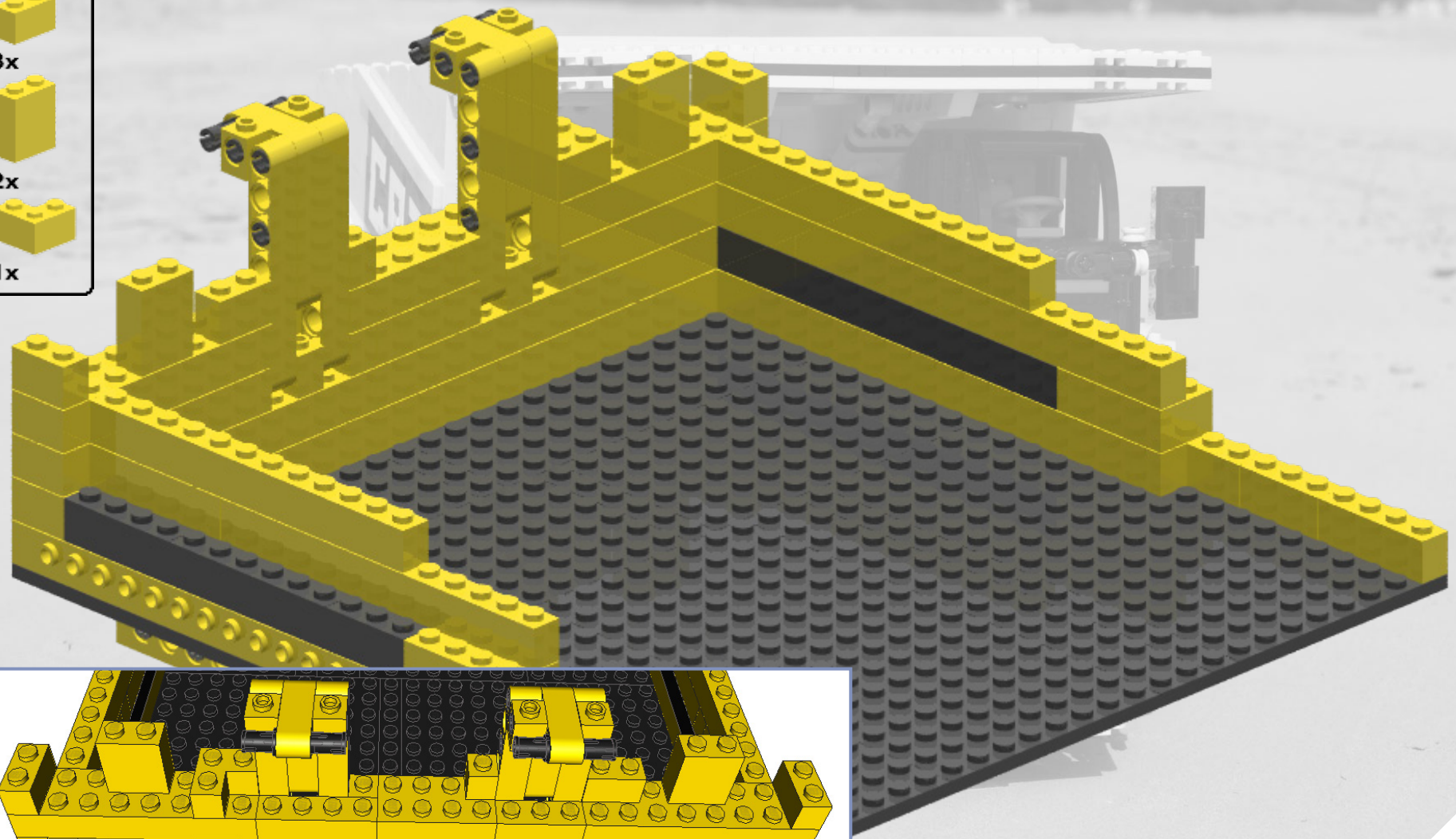

**EXAMPLE**



# Step 53

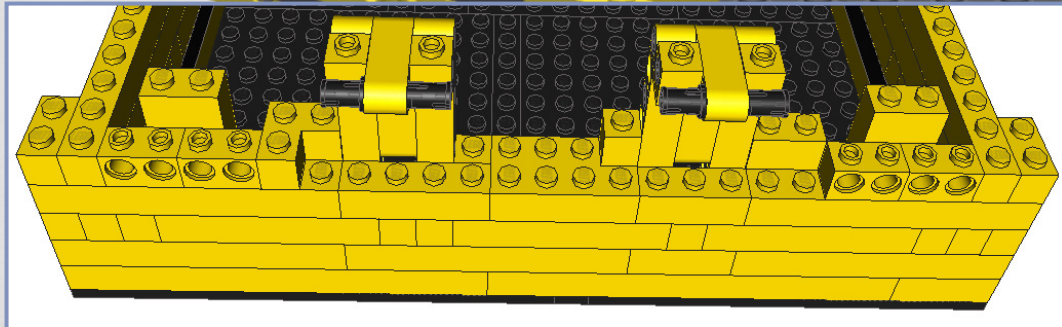
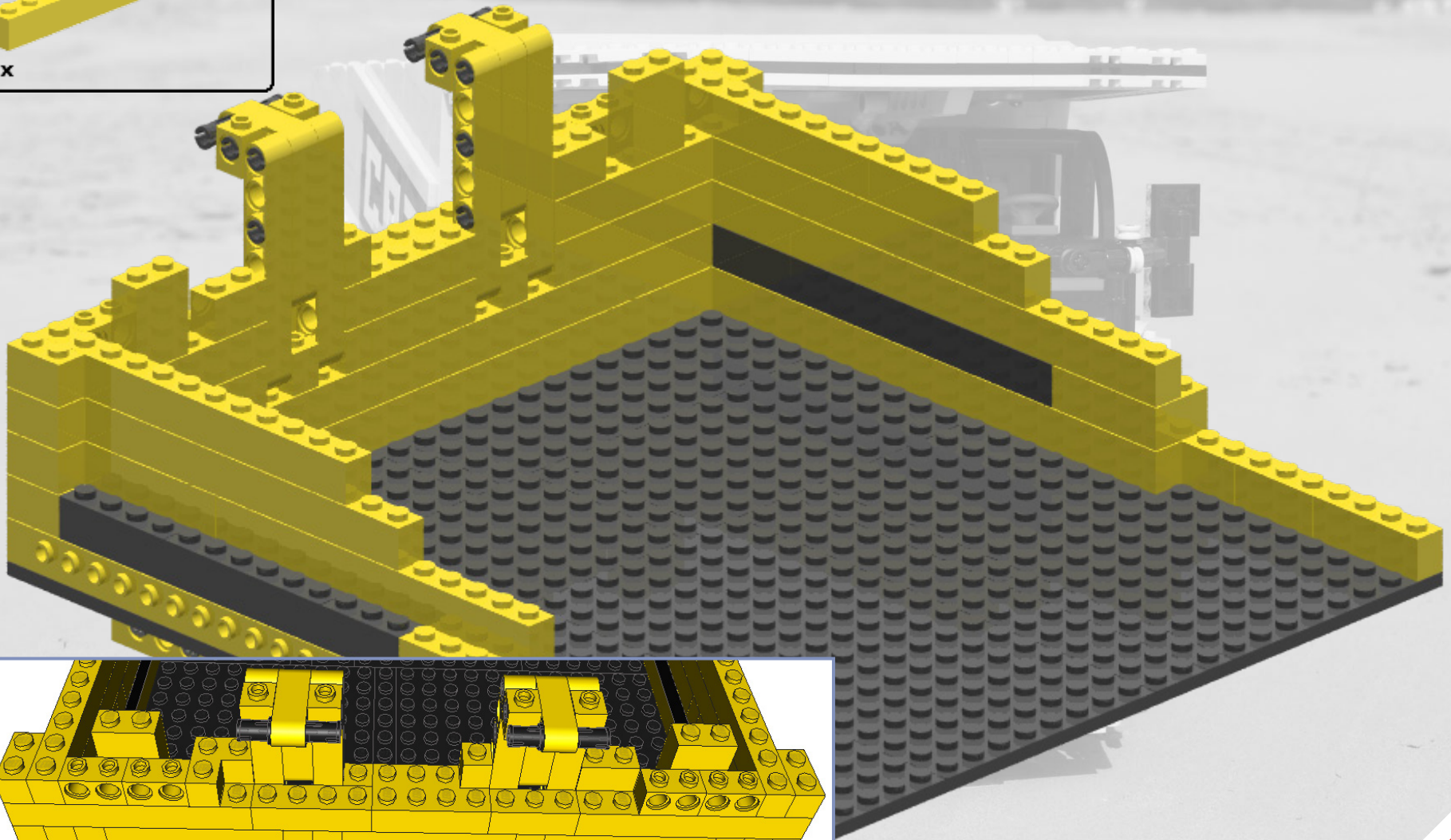
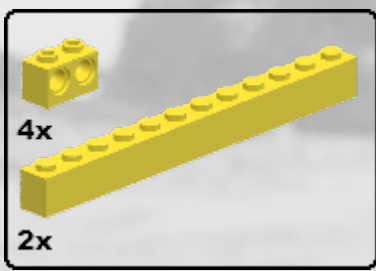

**EXAMPLE**



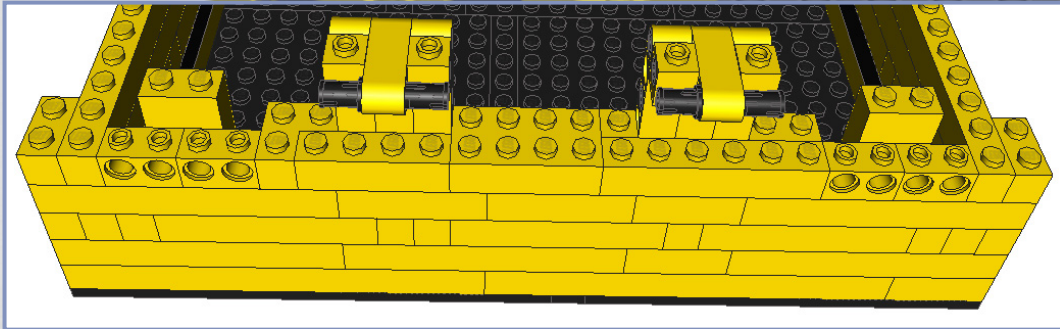
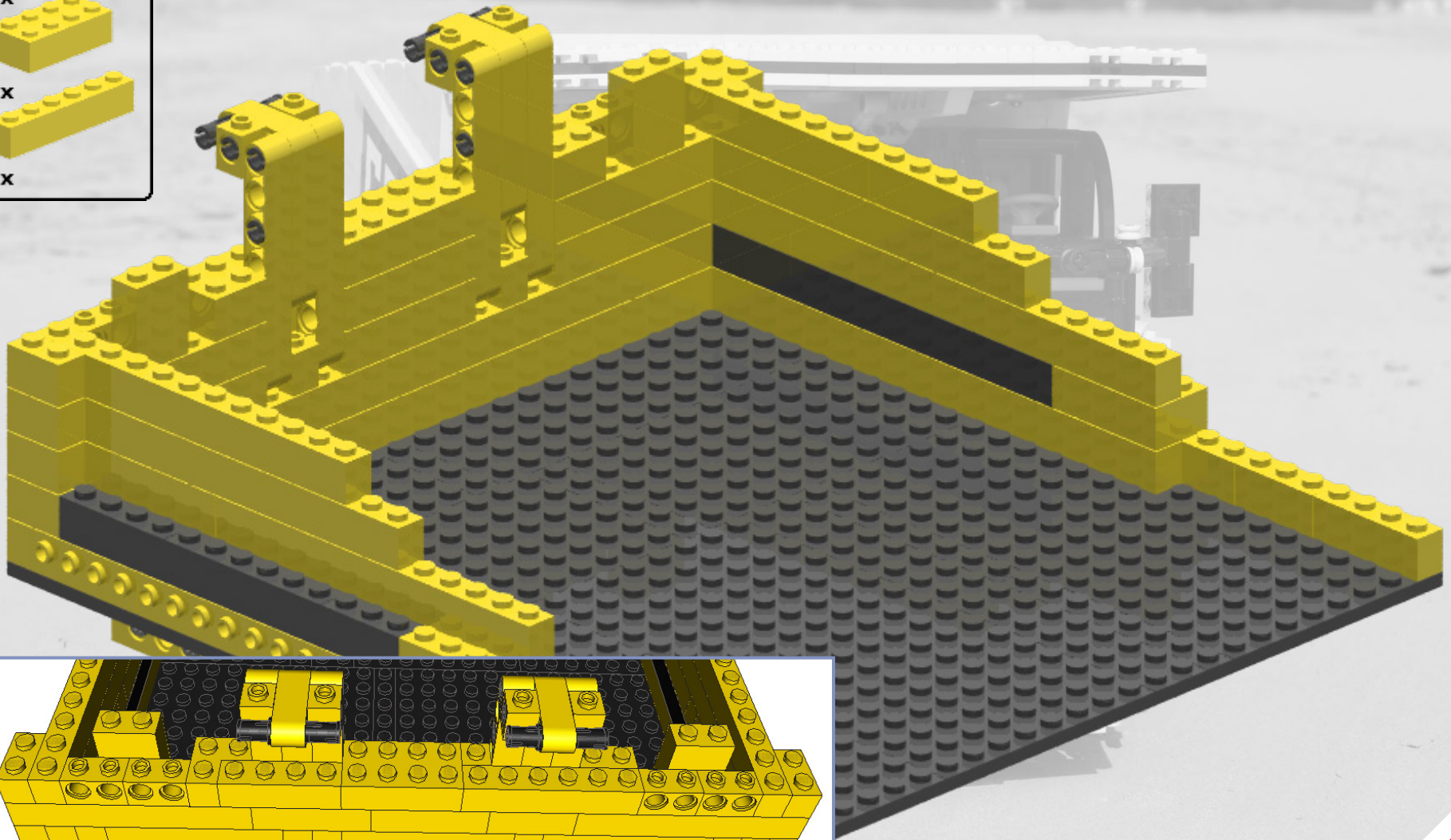
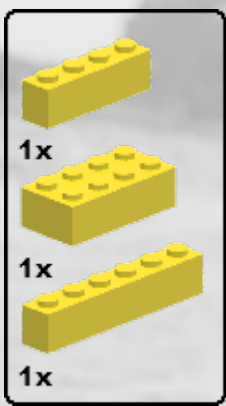

# Step 54



**EXAMPLE**



# Step 55

- 4x 
- 1x 
- 1x 

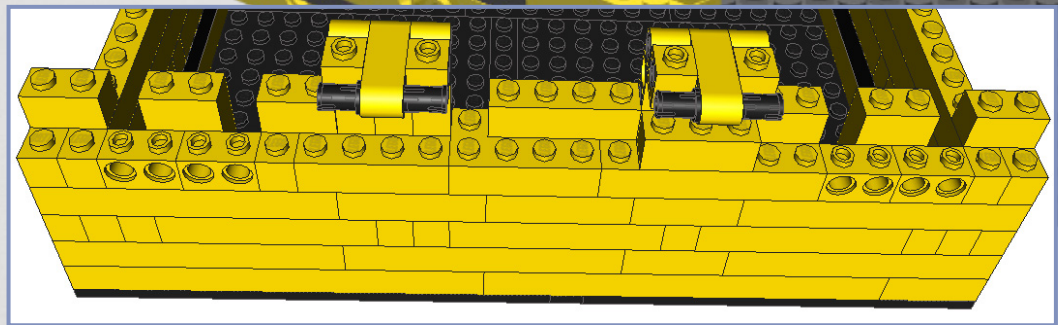
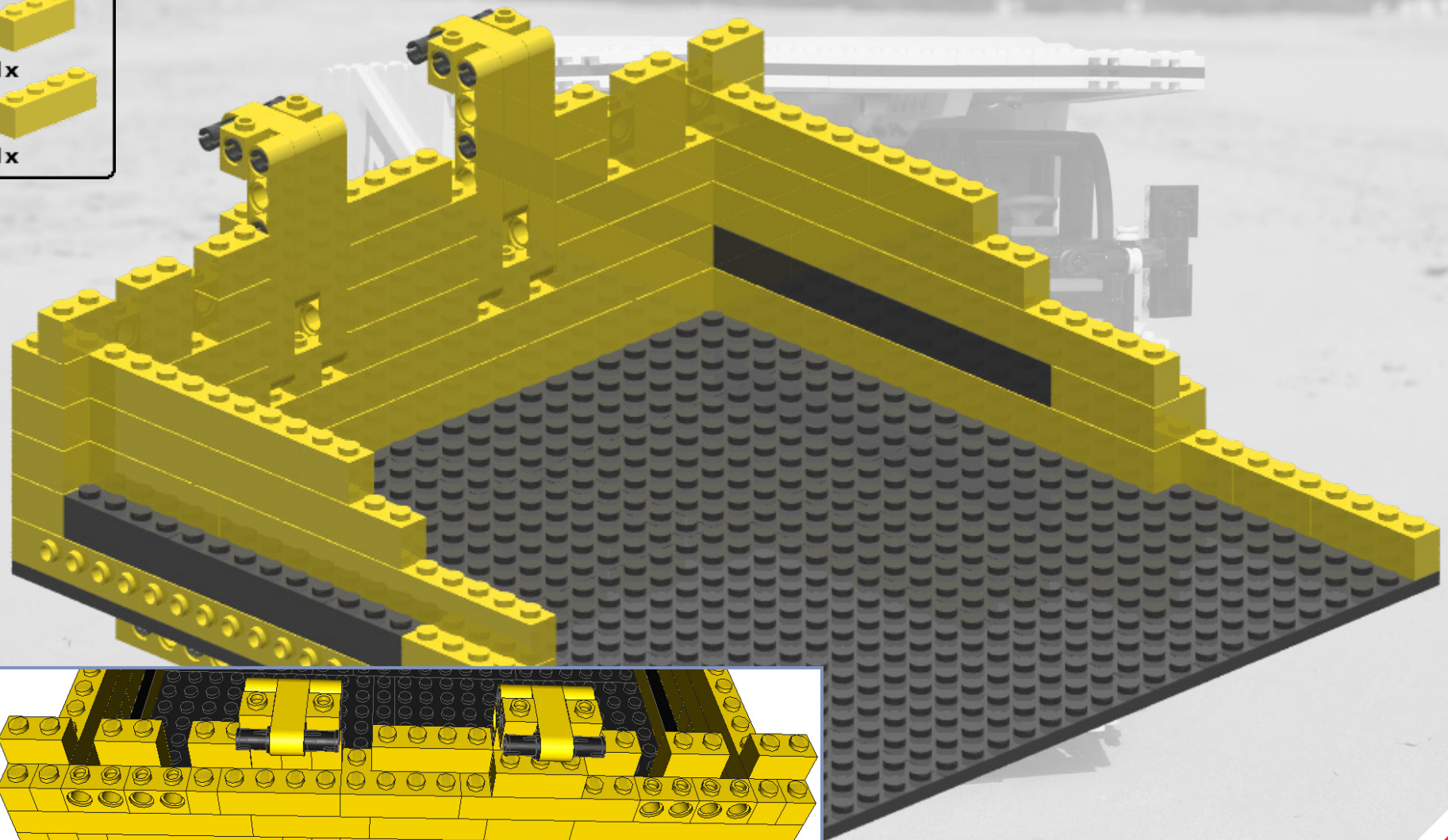

**EXAMPLE**



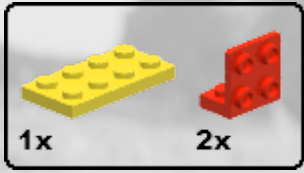

# Step 1



# Step 2

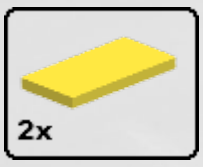
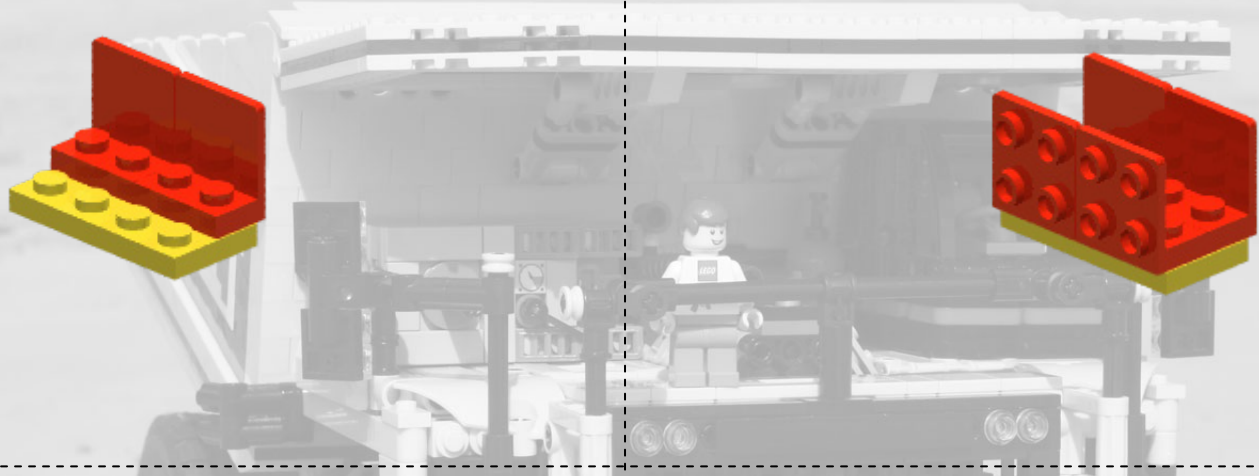

# Step 3

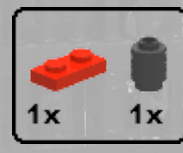

# Step 4



**EXAMPLE**





Trans Red

# Step 5

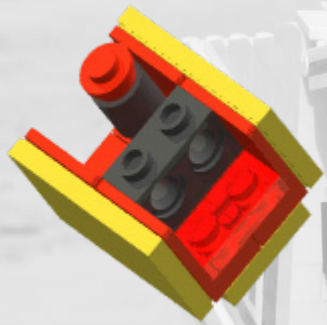

Trans Red

# Step 6



1x PF LED's wires

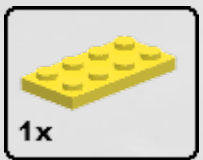
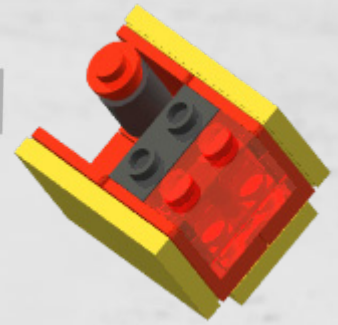
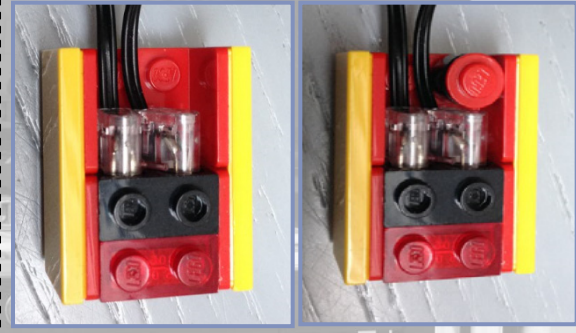

# Step 7

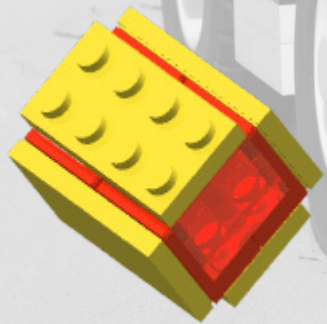

# Last step 8



**EXAMPLE**



# Step 56

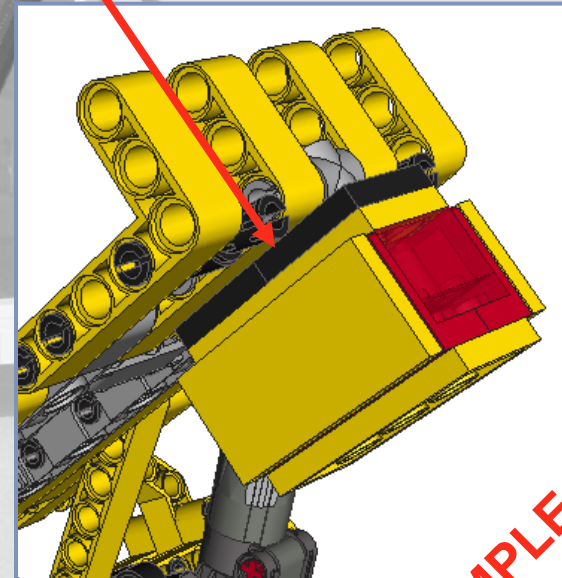
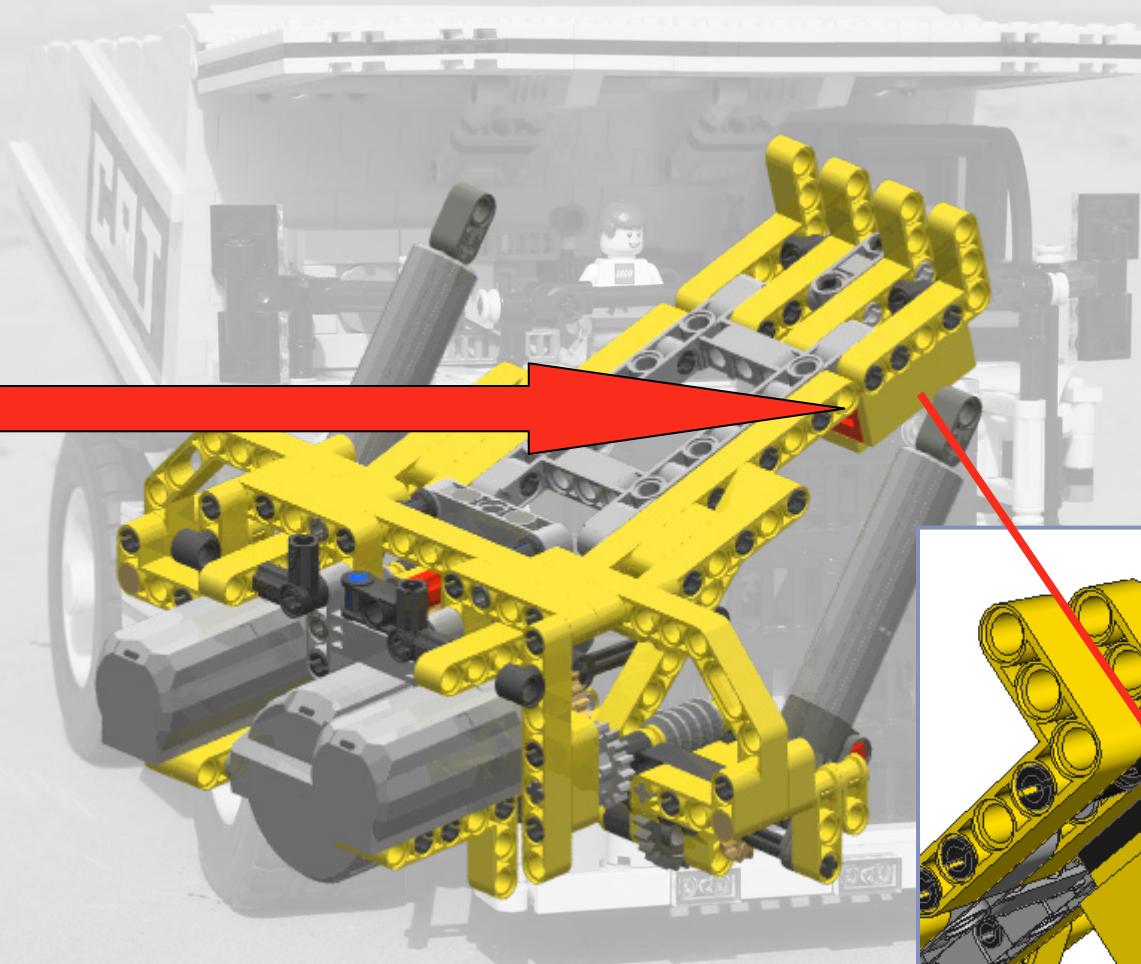

See next step 56a for wiring routing

**EXAMPLE**



# Step 56a

Step A

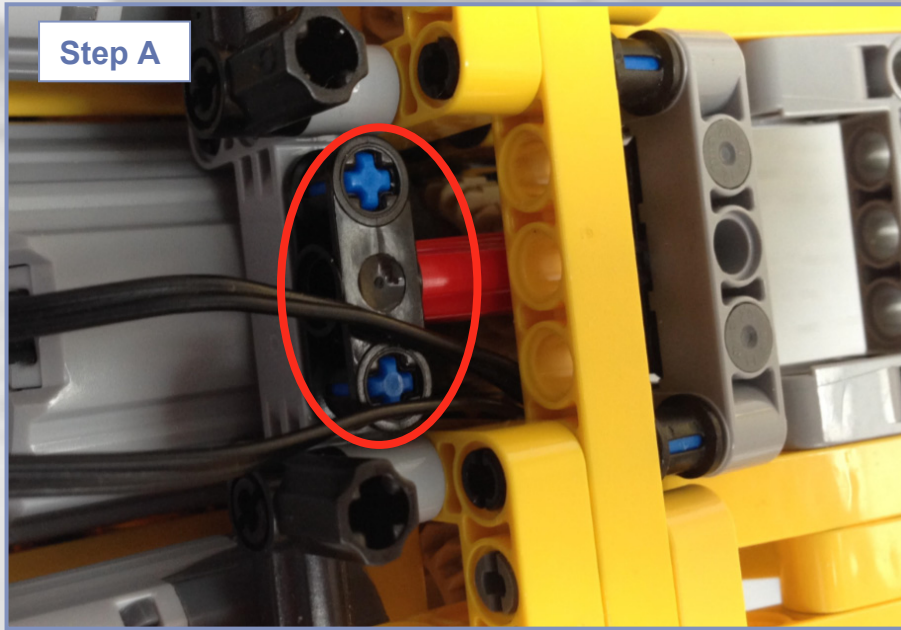

Temporary take the LED's out the rear-light unit to be able routing the LED wires through the chassis as mentioned in step A and step B.

To make the routing easier: temporary disconnect the black cross block and tan gear as mentioned in the red circles

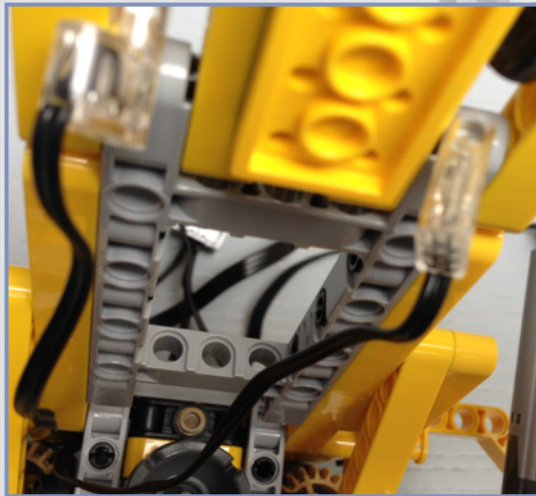

Step B

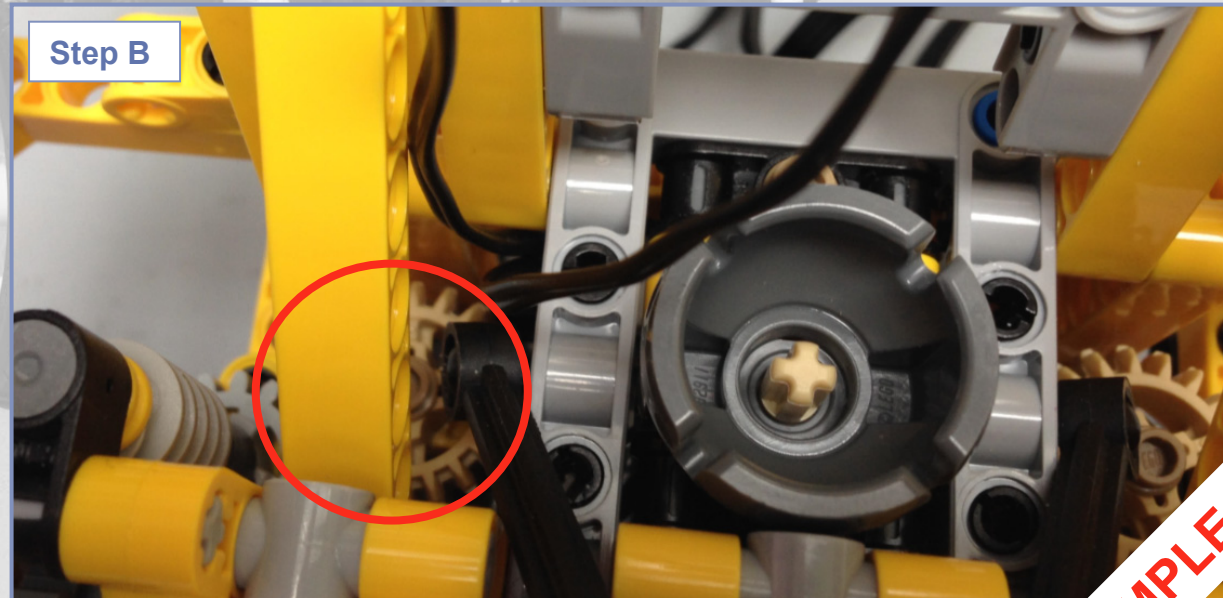

**EXAMPLE**





# Step 29

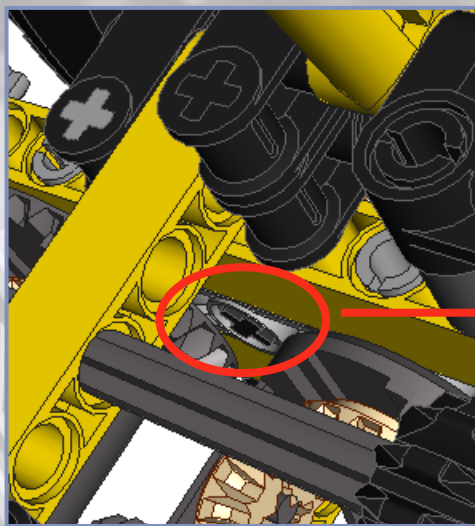

Make sure the 12L axles are not pushed into the differential area when mounting the wheels !



**EXAMPLE**



# Last step 30



Both sides

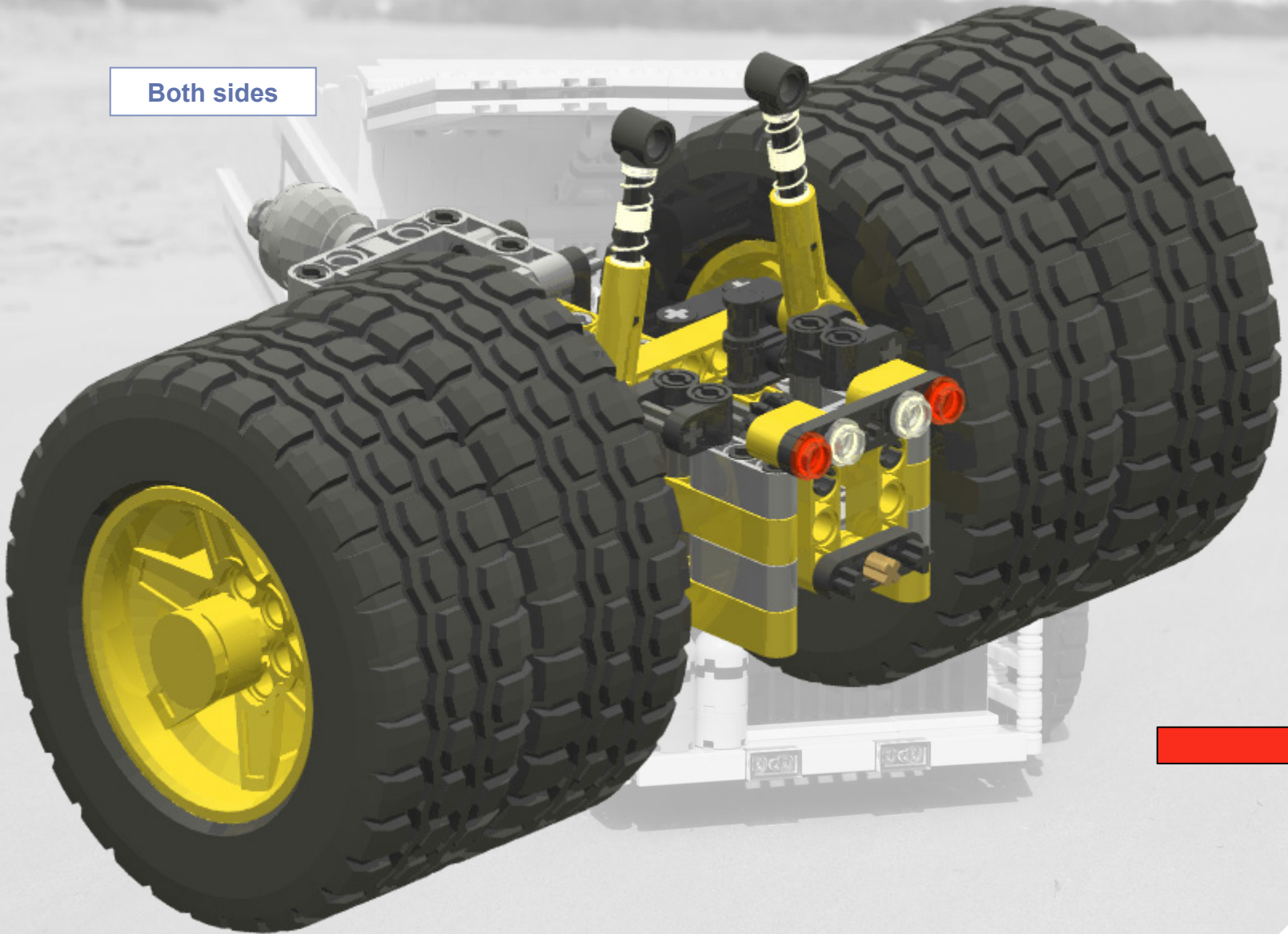

**EXAMPLE**



# Step 105

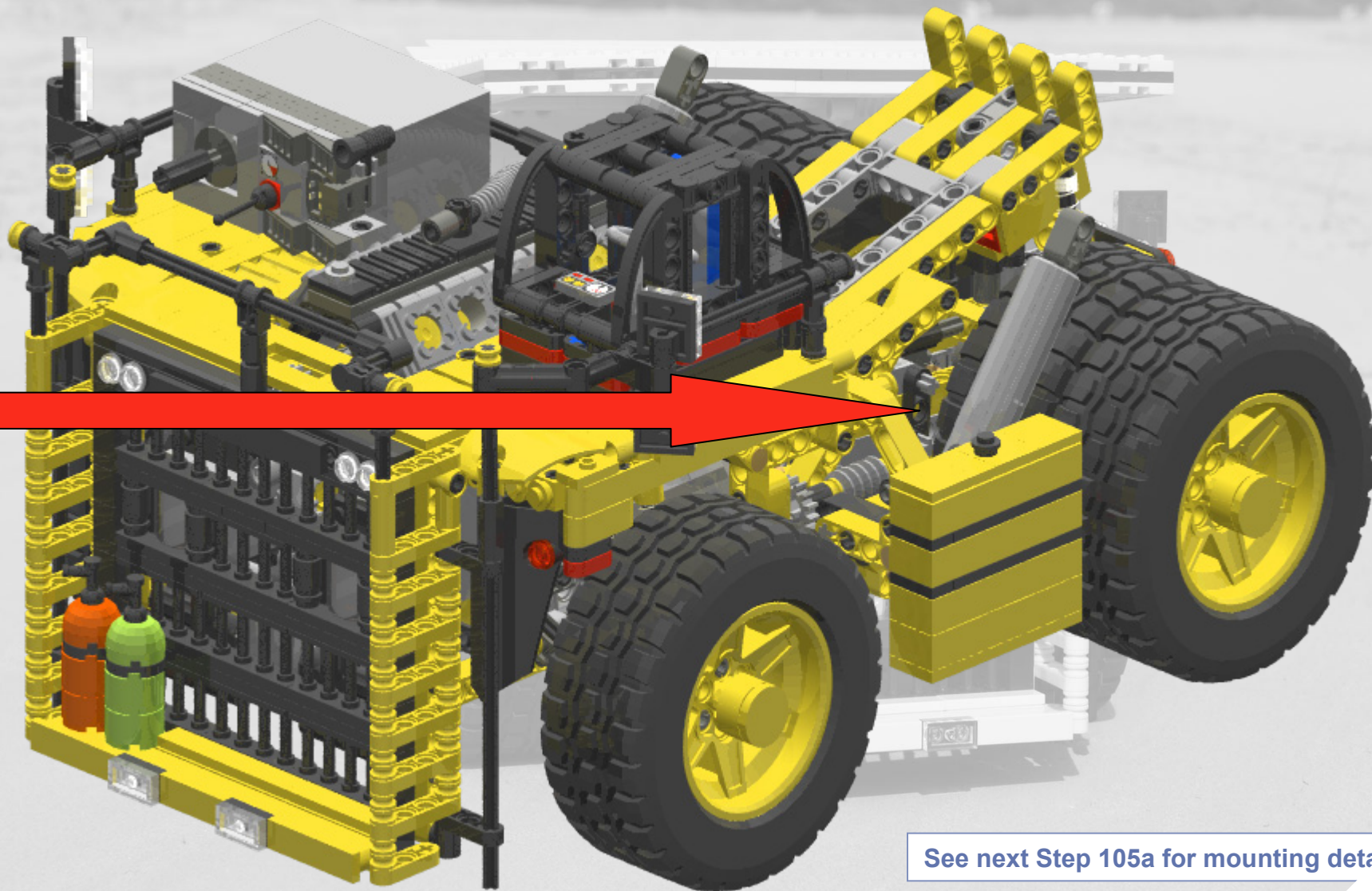

See next Step 105a for mounting details

**EXAMPLE**



Ready !



**EXAMPLE**

These building instructions are for personal usage and may not commercially used and/or sold. LEGO is a trademark of the LEGO group of companies which does not sponsor, authorize or endorse these building instructions. Copyright design: Han Crielaard, year 2016, [www.designer-han.nl](http://www.designer-han.nl)

